

# Datasheet APM10

## Particulate matter sensor

- Accurate measurement based on laser scattering principle
- Smallest measurable particle size of 0.3  $\mu\text{m}$
- Self-calibration
- Digital output
- Metal shell and stronger anti-EMC ability
- Size of 49×31.5×10.8mm

## Summary

APM10 is a digital particulate matter sensor based on laser scattering principle. It can detect particulate matter in real time. APM10 detects particle with size ranges from 0.3  $\mu\text{m}$  to 10  $\mu\text{m}$ . It also provides a variety of different digital output interfaces and has turn-on self-calibration function as well as good stability, small size, easy to be integrated.

## Application

APM10 has a wide range of application scenario, such as used in air purifiers, fresh air system, air quality monitoring equipment, and air conditioner.



Figure 1. APM10

## 1. Working principle

APM10 consists of a laser source and a light detector. As shown in Figure 2, the light detector collects scattered light intensity in real time. When the air flows through the duct, the particles inside the duct cause laser scattering. The light detector detects changes of the scattered light intensity. The subsequent acquisition circuit calculates the equivalent particle size and the number of particles of different sizes per unit volume based on the MIE theory.

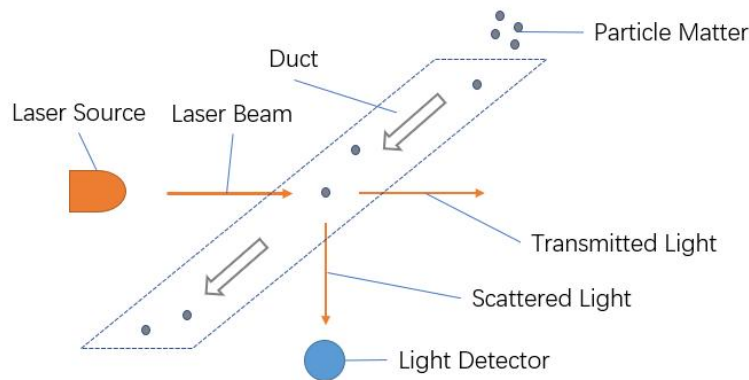

Figure 2. Sensor working principle

## 2. Sensor characteristic

Table 1. Sensor characteristic

Parameter	Minimum	Typical	Maximum	Unit
Supply voltage	4.75	5	5.25	V
Operating current	-	50	100	mA
Standby current	-	10	-	mA
Particle size	0.3	2.5	10	μm
Particle concentration	0	-	1000	μg/m <sup>3</sup>
Accuracy of PM2.5 <sup>1</sup>	±15 μg/m <sup>3</sup> (0~100 μg/m <sup>3</sup> ) ±15% M.V. (100~1000 μg/m <sup>3</sup> )			-
Data update period	1			s
Lifetime <sup>2</sup>	>3			Y
Size	49×31.5×10.8			mm
Operating temperature	-10	25	50	°C
Storage temperature	-30	25	70	°C

<sup>1</sup>Test condition: Temperature of 25±2°C; humidity of 50±10%RH; reference instrument is TSI8530; source of particle matter is from cigarettes.

<sup>2</sup>Depending on the operating environment.

### 3. Interface and communication protocol

#### 3.1 Pin assignment

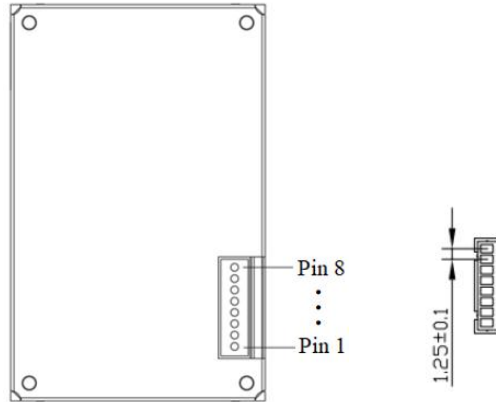

Figure 3. APM10 pinout (terminal model: MX1.25-8Y, Unit: mm)

Table 2. Pin definition

Pin	Name	Function
Pin 1	VCC	Power
Pin 2	GND	Ground
Pin 3	SET	0: I <sup>2</sup> C; 1 or float: UART
Pin 4	RX/SDA	UART RX/ I <sup>2</sup> C SDA
Pin 5	TX/SCL	UART TX/ I <sup>2</sup> C SCL
Pin 6	NC	-
Pin 7	NC	-
Pin 8	PWM	PWM output

#### 3.2 Communication interface

APM10 supports standard I<sup>2</sup>C communication protocol and contains two pins, SDA and SCL, both pins need to be connected with external 2kΩ~10kΩ pull-up resistors to VCC. The I<sup>2</sup>C communication address of the APM10 is 0x08 (7-bit), the write command is 0x10, and the read command is 0x11.

#### 3.3 I<sup>2</sup>C communication protocol

##### 3.3.1 Start measurement: 10 00 10 05 00 F6

Sending this command will enter the measurement mode.

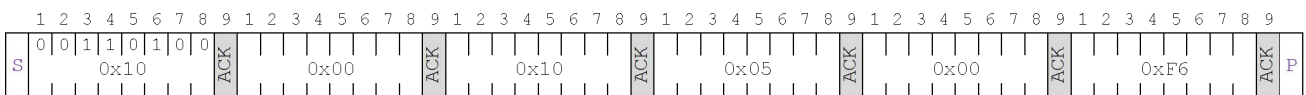

Master signal    Slave signal   S: Start   P: Stop   ACK: Acknowledge   NACK: Not acknowledge  
In the following commands, the meaning of the signal is the same.

##### 3.3.2 Stop measurement: 10 01 04

Sending this command will exit the measurement mode.

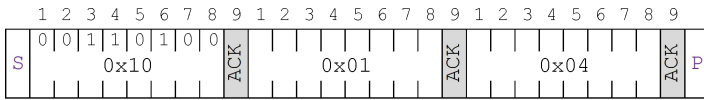

3.3.3 Read the data: 10 03 00 11 Data0\_H Data0\_L Data0\_CRC.....

Send this command to read the measured value.

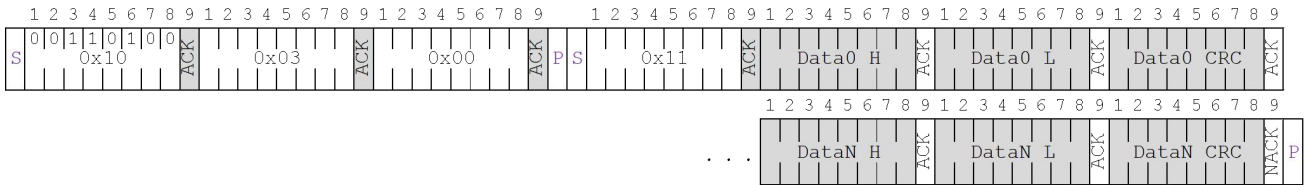

To read 30 bytes of valid data, the data description is shown in table 3.

Table 3. Data description

Byte	Data type	Description
0~2	Each particulate measurement data is 16 bits with the sequence of high byte, low byte and a CRC check value.	PM1.0 concentration=byte0*256+byte1 (unit: $\mu\text{g}/\text{m}^3$ ); Byte3 is the CRC checksum of byte0 and byte1;
3~5		PM2.5 concentration=byte3*256+byte4 (unit: $\mu\text{g}/\text{m}^3$ ); Byte5 is the CRC checksum of byte3 and byte4;
6~8		Reserved
9~11		PM1.0 concentration=byte9*256+byte10 (unit: $\mu\text{g}/\text{m}^3$ ); Byte11 is the CRC checksum of byte9 and byte10;
12~14		Reserved
15~17		Reserved
18~20		Reserved
21~23		Reserved
24~26		Reserved
27~29		Reserved

APM10 adopts CRC8 calculation with an initial value of 0xFF and polynomial of 0x31 ( $x^8+x^5+x^4+1$ ) to check data integrity. The code is as follows:

```

//*****
// Function name: Calc_CRC8
// Function: CRC8 calculation, initial value: 0xFF, polynomial:
// 0x31 (x8 + x5 + x4 + 1)
// Parameter: u8*dat: needs to verify the first address of the
// data; u8 Num: CRC verifies the data length
// Return: Check value calculated by crc:
//*****
unsigned char Calc_CRC8(unsigned char *data, unsigned char Num)
{
    unsigned char bit,byte,crc=0xFF;

    for(byte=0; byte<Num; byte++)
    {
        crc^=(data[byte]);
        for(bit=8;bit>0;--bit)
        {
            if(crc&0x80)
                crc=(crc<<1)^0x31;
            else
                crc=(crc<<1);
        }
    }
    return crc;
}
    
```

### 3.4 UART communication protocol

#### 3.4.1 Serial port parameter

Table 4. Serial port parameter

Data domain	Parameter
Baud rate	1200
Data bit	8 bits
Stop bit	1 bit
Parity	None

#### 3.4.2 Communication protocol format

Table 5. Serial protocol format

Frame head	Fixed code	Length (1-byte)	Command (1-byte)	Data (n bytes)	Check
FE	A5	XX	XX	XX	CS

Table 6. Serial protocol description

Protocol domain	Detailed description
Frame head	Value fixed to FE
Fixed code	Sensor category, value fixed to A5
Length	Length of data
Command code	Operation instruction code
Data	Data to be read or written
Checksum	Checksum (low byte) = fixed code + length + command code + data

### 3.4.3 Serial port protocol command

Table 7. Serial port protocol command code

Function name	Command word
Read the PM2.5 measurement	0x00
Read the PM1.0, PM2.5, PM10 measurement	0x01

a) Read the PM2.5 measurement result

Table 8. Read the PM2.5 measurement result

Send	FE A5 00 00 A5
Response	FE A5 02 00 DF1 DF2 [CS]
Description	PM2.5 meas. value = DF1×256 + DF2 (unit: $\mu\text{g}/\text{m}^3$ )

b) Read the PM1.0, PM2.5, PM10 measurement result

Table 9. Read the PM1.0, P M2.5 and PM10 measurement result

Send	FE A5 00 01 A6
Response	FE A5 02 00 DF11 DF12 DF21 DF22 DF31 DF32 [CS]
Description	PM1.0 Meas. Value = DF11×256 + DF12 (Unit: $\mu\text{g}/\text{m}^3$ ) PM2.5 Meas. Value = DF21×256 + DF22 (Unit: $\mu\text{g}/\text{m}^3$ ) PM10 Meas. Value = DF31×256 + DF32 (Unit: $\mu\text{g}/\text{m}^3$ )

### 3.5 PWM output

Table 10. PWM output

PM2.5 concentration output range	0~1000 $\mu\text{g}/\text{m}^3$
Cycle	1000 ms±5%
High-level output at the cycle start section	200 $\mu\text{s}$ (Theoretical value)
Mid-cycle	1000 ms±5%
The end of the cycle section of the low-level transmission	200 $\mu\text{s}$ (Theoretical value)

Note: 1) PM2.5 concentration values obtained by PWM output:  $P = 1000 \times (\text{TH}) / (\text{TH} + \text{TL})$ ;  
 P is the calculated PM2.5 concentration value in  $\mu\text{g}/\text{m}^3$ ;  
 TH is the time of high levels in one output cycle.  
 TL is the time of low levels in one output cycle.  
 2) The values calculated by PWM represent only PM2.5.

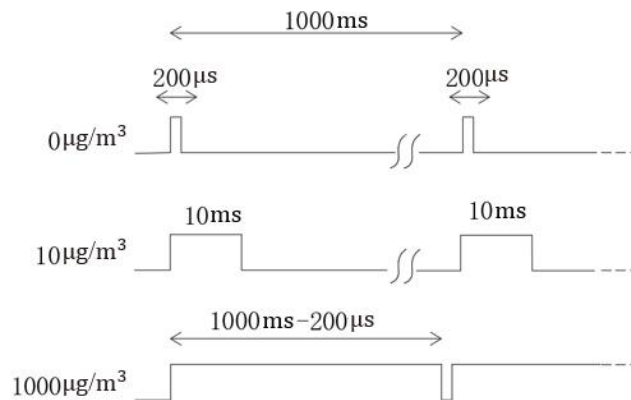

Figure 5. PWM output timing diagram

### 4. Dimension

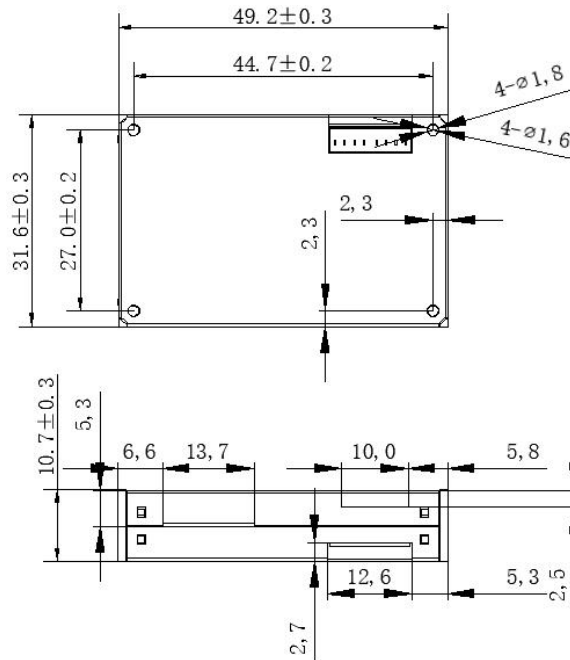

Figure 6. APM10 dimension (unit: mm, tolerances: ISO2768-mK; Unmarked tolerance ± 0.2mm)

### 5. Packaging

APM10 is packed in a plastic tray with 25 sensors per tray as shown in Figure 7.

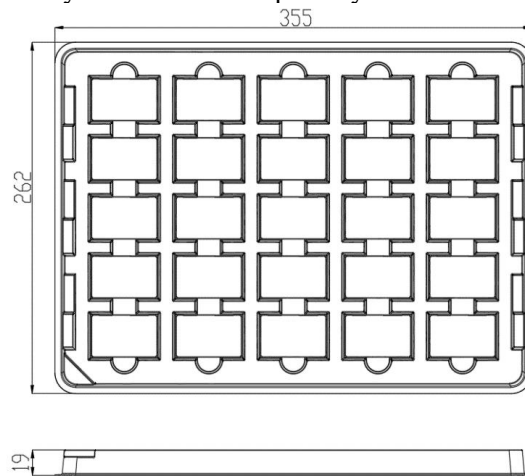

Figure 7. Size of plastic tray (unit: mm, tolerances: ISO2768-mK)

The weight of one sensor is about 22 g; the weight of one tray with 25 sensors is about 550 g.

### 6. Precaution

6.1 Since the metal shell of the sensor is connected to the internal power supply, do not connect the sensor shell to external circuits or other instrument shell.

6.2 The side of sensor with air inlet and outlet should be closely attached to the vent on the inner wall of target instrument. No obstructions should be around the air outlet within 2 cm.

There must be barrier between air inlet and outlet to prevent air returning directly from the air outlet to the inlet.

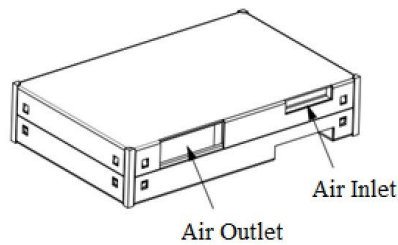

Figure 8. Air inlet and outlet

6.3 The size of air inlet and outlet in equipment should be larger than that of air inlet in sensor.

6.4 When used for purifier, do not install the sensor directly into the duct of purifier. An independent space should be designed to install the sensor to isolate the sensor from the purifier's duct.

6.5 Sensor should be installed at least 20 cm above the ground, otherwise there may be large particles such as dust, floating material or fluff causing failure of fan in sensor. Appropriate pre-filter is strongly recommended to be used.

6.6 Do not disassemble the sensor to prevent irreversible damage.

6.7 Sensors has been tested and all in good consistency. Do not take a third-party testing instrument or data as the comparison standard. If the user wants the measurement data to be consistent with third-party testing equipment, the data can be fitted and calibrated according to the actual measurement results.

6.8 This sensor is suitable for normal indoor environment, if use in the following environment, the sensor's data consistency may reduce due to excessive dust accumulation, oil accumulation or water entering:

- a) Dust concentration greater than  $300 \mu\text{g}/\text{m}^3$  in 6 months one year, or dust concentration greater than  $500 \mu\text{g}/\text{m}^3$  in 2 months one year.
- b) Lampblack environment.
- c) High water fog environment.
- d) Outdoor.



## Warning and personal injury

Do not apply this product to safety protection devices or emergency stop equipment, and any other applications that may cause personal injury due to the product's failure. Do not use this product unless there is a special purpose or use authorization. Refer to the product data sheet and application guide before installing, handling, using or maintaining the product. Failure to follow this recommendation may result in death and serious personal injury.

The Company will not bear any compensation for personal injury and death arising therefrom, and will exempt the company's managers and employees, affiliated agents, distributors and any other claims that may arise therefrom, including: various costs, claims, lawyer fees, etc.

## Quality assurance

Guangzhou Aosong Electronic Co., Ltd. provides the following quality guarantee to the direct buyers of its products (from the date of delivery), based on the technical specifications in the data manual of the products published by Aosong as the standard. Within the warranty period, if the product is confirmed to be defective, the company will provide free repair or replacement.

Description of warranty period

Accessories category	Shelf life
APM10 Laser particle sensor	12 Months

The company is only responsible for products that are defective when used in applications that meet the technical conditions of the product. The company does not make any guarantees or written statements about the application of its products in those special applications. At the same time, the company does not make any promises about the reliability of its products when applied to products or circuits not provided by Aosong.

This manual may be changed at any time without notice.

Guangzhou Aosong Electronic Co., Ltd. reserves the right of final interpretation of this product.

Copyright ©2024, ASAIR®